



Image may differ from product. See technical specification for details.

W 6008-2Z

Stainless steel deep groove ball bearing with integral sealing

Stainless steel single row deep groove ball bearing with seals or shields on both sides, provide greater chemical and corrosion resistance. As with deep groove ball bearings generally, they are particularly versatile, have low friction and are optimized for low noise and low vibration, which enables high rotational speeds. They accommodate radial and axial loads in both directions, are easy to mount, and require less maintenance than other bearing types. The integral sealing can significantly prolong bearing service life because it keeps lubricant in the bearings and contaminants out.

- Greater chemical and corrosion resistance
- Integral sealing prolongs bearing service life
- Typical benefits of single row deep groove ball bearings

Overview

Dimensions

Bore diameter	40 mm
Outside diameter	68 mm
Width	15 mm

Properties

Filling slots	Without
Number of rows	1
Locating feature, bearing outer ring	None
Bore type	Cylindrical
Cage	Sheet metal
Matched arrangement	No
Radial internal clearance	CN
Tolerance class	Normal
Material, bearing	Stainless steel
Coating	Without
Sealing	Shield on both sides
Sealing type	Non-contact
Lubricant	Grease
Relubrication feature	Without

Performance

Basic dynamic load rating	14.6 kN
Basic static load rating	11.4 kN
Reference speed	22 000 r/min
Limiting speed	11 000 r/min

Logistics

Product net weight	0.175 kg
eClass code	23-05-08-01
UNSPSC code	31171504

Technical specification

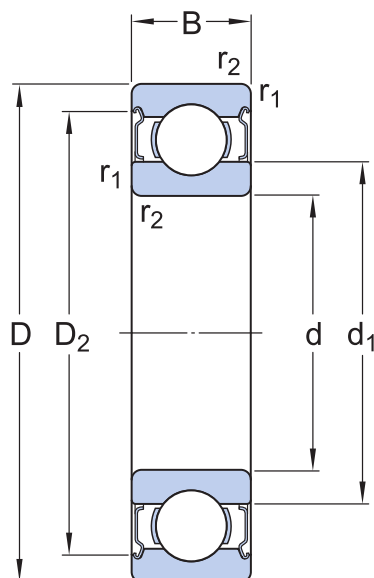

Dimensions

d	40 mm	Bore diameter
D	68 mm	Outside diameter
B	15 mm	Width
d_1	≈ 49.2 mm	Shoulder diameter
d_2	≈ 49.2 mm	Recess diameter
D_2	≈ 62.5 mm	Recess diameter
$r_{1,2}$	min. 1 mm	Chamfer dimension

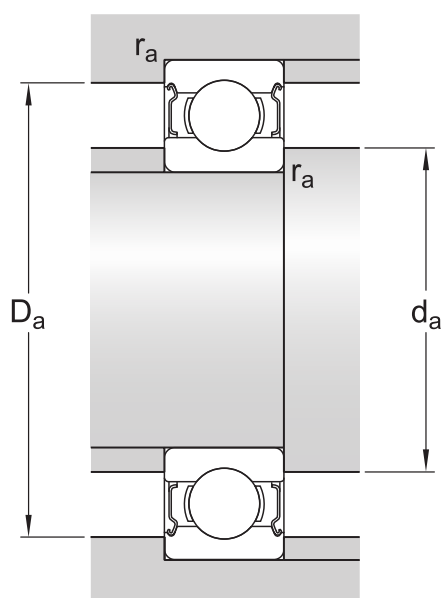

Abutment dimensions

d_a	min. 45 mm	Diameter of shaft abutment
d_a	max. 49 mm	Diameter of shaft abutment
D_a	max. 63.5 mm	Diameter of housing abutment
r_a	max. 1 mm	Radius of shaft or housing fillet

Calculation data

Basic dynamic load rating	C	14.6 kN
Basic static load rating	C_0	11.4 kN
Fatigue load limit	P_u	0.49 kN
Reference speed		22 000 r/min
Limiting speed		11 000 r/min
Minimum load factor	k_r	0.03
Calculation factor	f_0	15.2

Mass

Mass bearing

0.18 kg

Tolerance class

Dimensional tolerances	Normal
Radial run-out	Normal
